

EXPERIMENTAL RESEARCH

Thoughts for experimentalists

J. Carlos Santamarina
Georgia Tech - 2012

Causality

*The craftsmanship of nature provides extraordinary pleasures for those who can recognize the **causes** in things* (Aristotle 384-322 BC)

God is not playing dice with the universe
(A. Einstein – 1879-1955)

Correlation does not imply causality



Read ... *read a lot!*

Read (first verse revealed – Quran – 609-632)

If I have seen further, it is by standing on the shoulders of giants

(Newton 1643-1727)

How is it that we know so little, given that we have so much information?

(Noam Chomsky)

Read ... *read a lot!*

Read (first verse revealed – Quran – 609-632)

If I have seen further, it is by standing on the shoulders of giants
(Newton 1643-1727)

How is it that we know so little, given that we have so much information?
(Noam Chomsky)

known

unknown

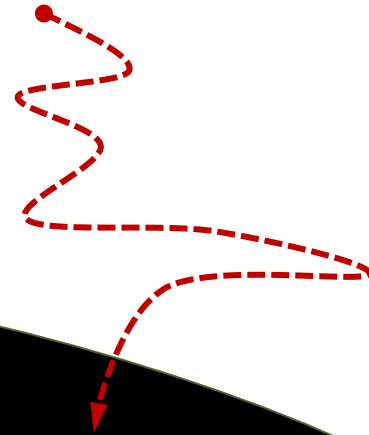

→ list the 10 (...50!) most important references in your field (consider ALL fields of knowledge)

Ask a good question... AND... meaningful !

Ask an impertinent question, and you are on the way to a pertinent answer
(J. Bronowski, Ascent of man)

*For every difficult question,
there is an answer that is clear and simple ... and wrong*
(G. Bernard Shaw 1856-1950)

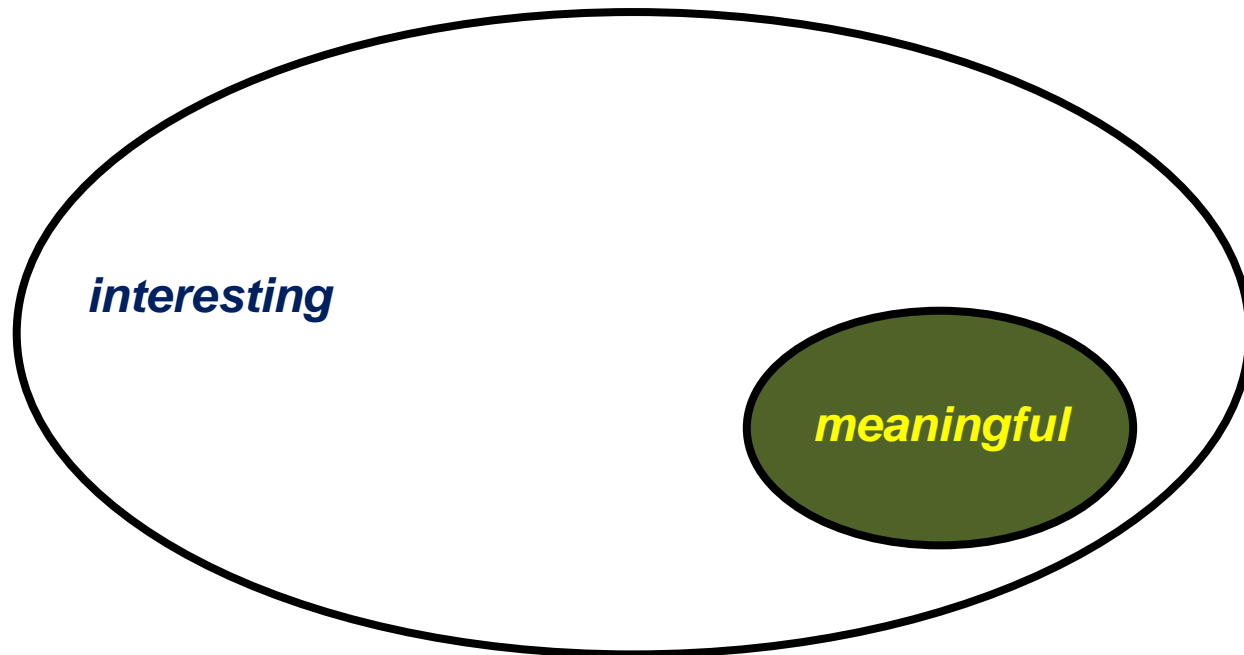

→ list the most important questions that guide your research ... interesting? meaningful?

Thought Experiments

If I pursue a beam of light with the velocity c (velocity of light)...

(A. Einstein - 1879-1955) influenced by Ernst Mach (1838-1916)

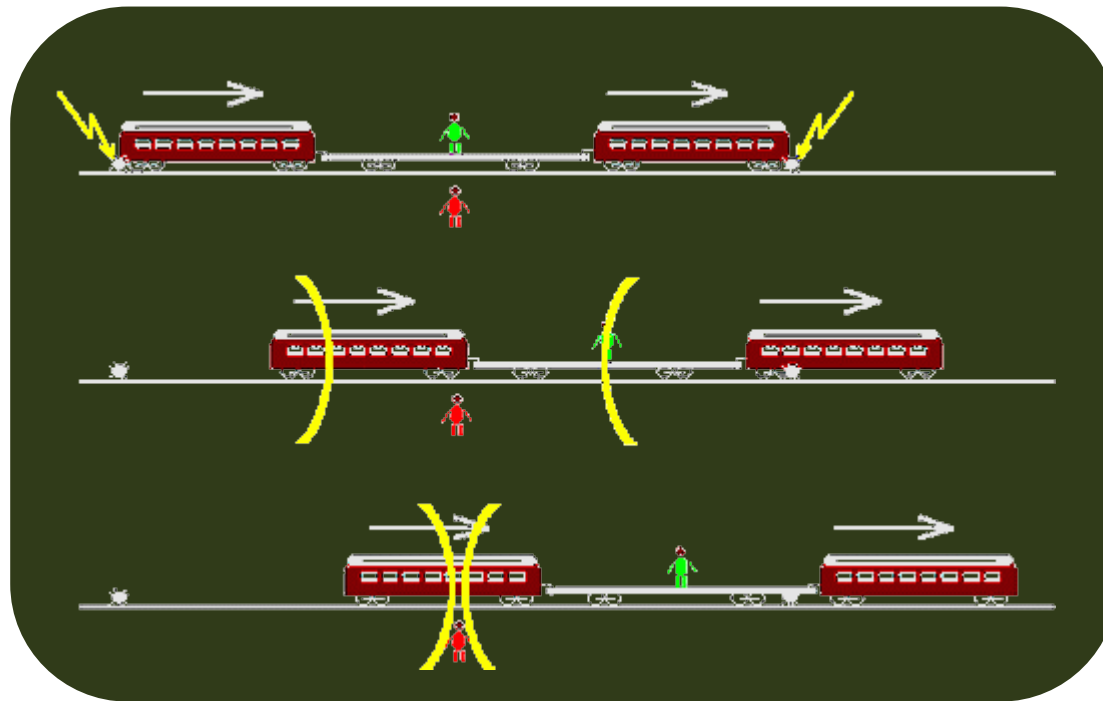

www.outersecrets.com

Feel like a grain ... or a water molecule....

→ run the phenomenon in your mind.... feel as a grain... feel as a water molecule...

Remain Skeptical

What we want to measure ...

what we measure...

what we think we measured...!

(unknown)

The devil is in the details

(popular saying)

damping cemented soils in RC



*low-frequency permittivity
(electrode polarization)*



pore pressure transducer installation

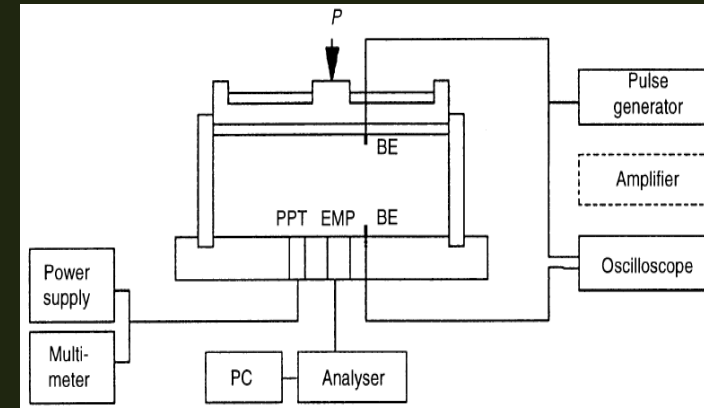

→ understand the fundamentals of your measurement setup/phenomenon/device/analysis

Cognitive Biases → Remain Skeptical

We are poor inherent statisticians (Hogarth)

Cognitive Limitations

Miller's 7 2

Three clues: often account for 80% variance in individuals' response

More data: more confidence yet no improvement in quality of decision

Primacy and recency

Poor statistician

Disregard sample size on the variance of the mean

Gambler's fallacy

Inability to conceive randomness

Inability to recognize regression towards the mean

Law of small numbers: assume that small numbers represent population

→ read about inherent cognitive biases (e.g., Hogarth; Tversky & Kahneman)

Scales – Dimensionless Ratios

...a great giant [of] the same proportion of limb as that found in an ordinary man [with the same bone hardness and strength] he will fall and be crushed under his own weight.

(Galileo 1564-1642)

and God saw the mountains move

Book of Deborah

The space of science is the dimensionless space

A test must be a good model of reality

To expect the model to be identical to the prototype is the denial of modeling

(Ovansen? 1970's)

Models must satisfy similarity at boundary conditions as well

Buckingham's π theorem. A phenomenon described by n variables in terms of r dimensions can be equally described by $n-r$ dimensionless variables

(Buckingham 1867-1940)

Examples from Aussois 2012

fiber-grain interaction

Olufemi Ajayi et al.

$$\frac{\delta}{d_g} = \frac{1}{d_g} \frac{PL^3}{48EI} = \frac{1}{d_g} \frac{\sigma' d_g^2 (2d_g)^3}{48E \frac{\pi d_f^4}{64}} = \alpha \frac{\sigma'}{E} \left(\frac{d_g}{d_f} \right)^4$$

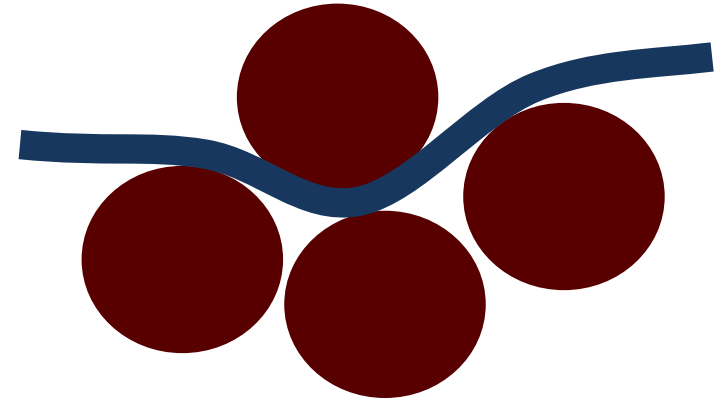

tunnel advance rate on deformations

G. Anagnostou

$$\frac{t_{\text{tunnel adv}}}{t_{\text{dissipation}}} = \frac{D_{\text{tun}} / v}{D_{\text{tun}}^2 / c_v} = \frac{c_v}{v \cdot D_{\text{tun}}} = \frac{\alpha \frac{Gk}{\gamma_w}}{v \cdot D_{\text{tun}}} = \alpha \frac{k}{v} \frac{G}{\gamma_w D_{\text{tun}}}$$

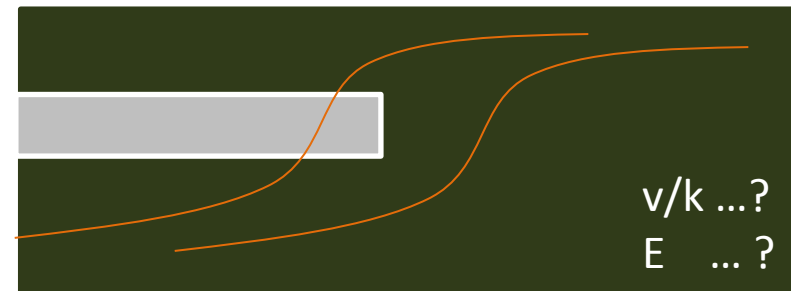

→ identify key variables and dimensions in your problem ... combine into governing π 's

Examples from Aussois 2012

imbibition

Viggiani and Hall

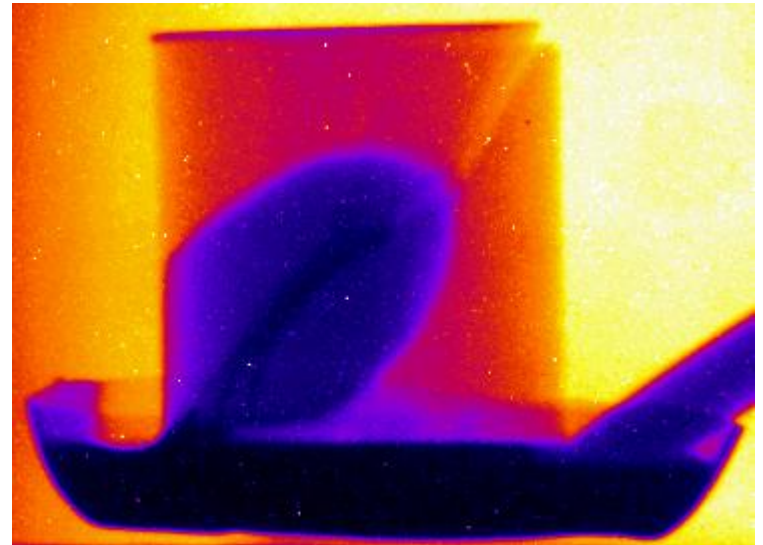
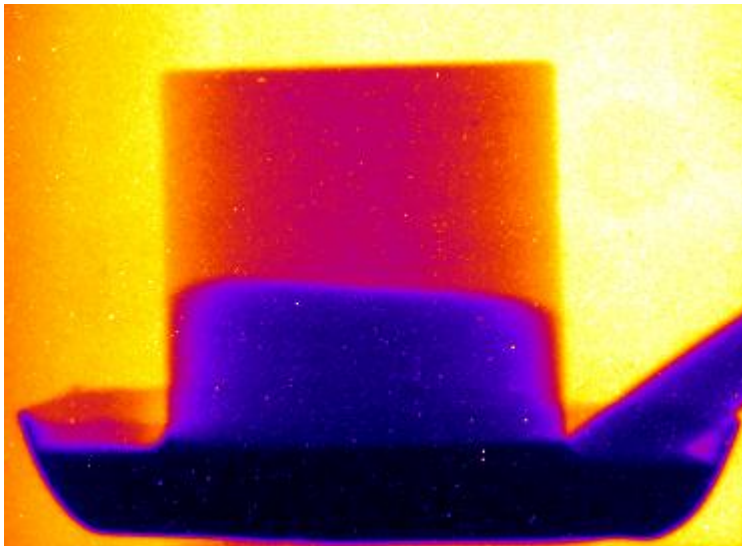

The Inherent Limitation

A measurement always alters the measurand
(thermodynamics)

Geo-Examples

CPT?

soil sampling?

membrane?

thermocouple or thermistor?

waves?

....

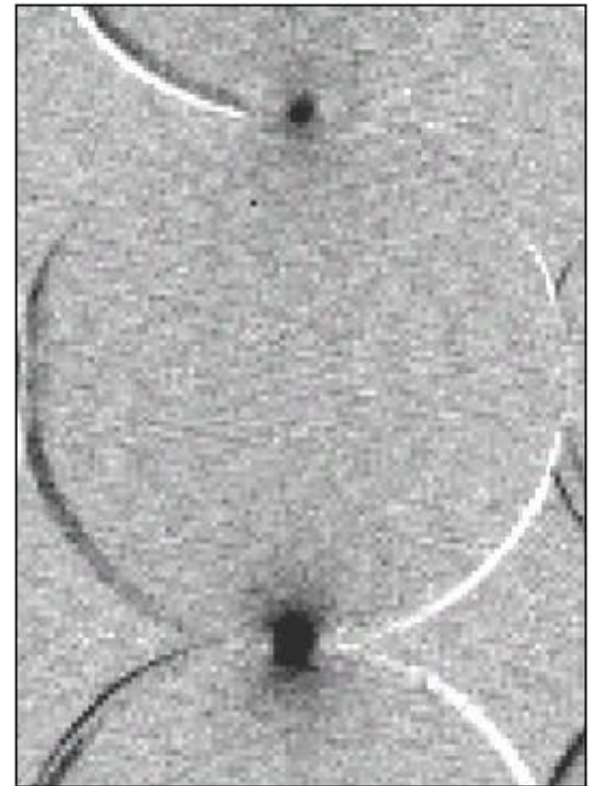

→ critically review your experimental procedure: effect of measurement on measurand?

Design: Make it elegant

It may work... but it is not elegant ... start over !

Noel Etchegoyen (1948-2010)

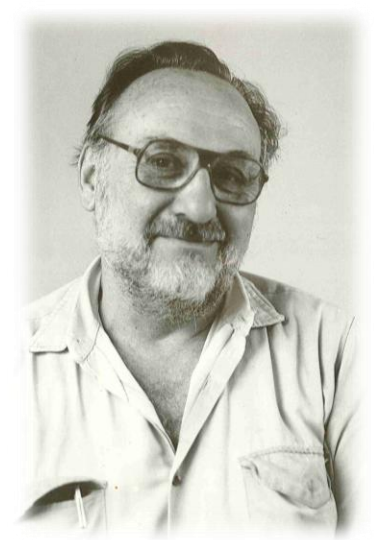

Implies: creative solution
simplicity - avoids excesses
is harmony and balance
carefully designed details

Elegant experiment:

starts with an important, well defined question
based on profound physical understanding of the process under study
focused on the essence of the process
prevents (minimizes) secondary effects
well-controlled boundary conditions
optimal use of material - well balanced equipment design (FS's)
proper selection and installation of sensors
designed for maximum signal-to-noise ratio
well balanced measurement resolution for all parameters
effective for subsequent data analysis and interpretation

→ Train your eye: Visit several laboratories, ask about the experiments... elegant?

Design: Noise Control

Improve experiment at the lowest possible level

Reduce cause of uncertainty at its source !

It is all about noise control - reduce noise at its source !

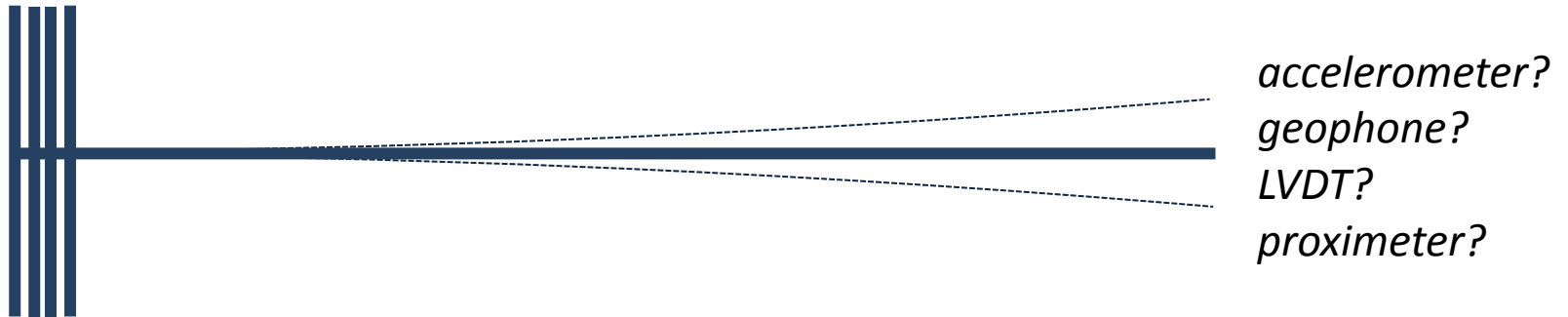

→ reconsider instrumentation selection. Noise? (thermal, mechanical, ELM, chemical, bio)

Analysis

The book of nature is written in mathematical characters

(Galileo 1564-1642)

Plurality must not be posited without necessity

Shave away unnecessary assumptions... Favor simplicity

(William of Ockham 1285–1349)

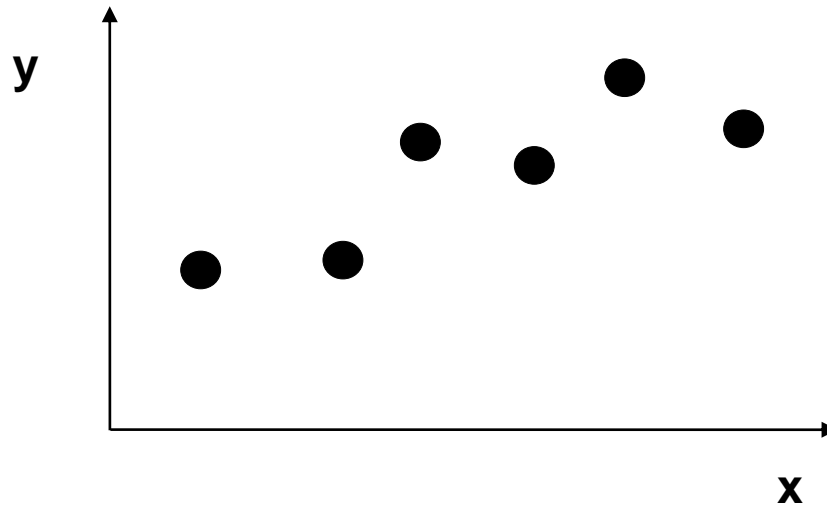

Analysis

Data analysis = Inverse problem

Typically, there is much less information than data

Design information-rich experimental studies

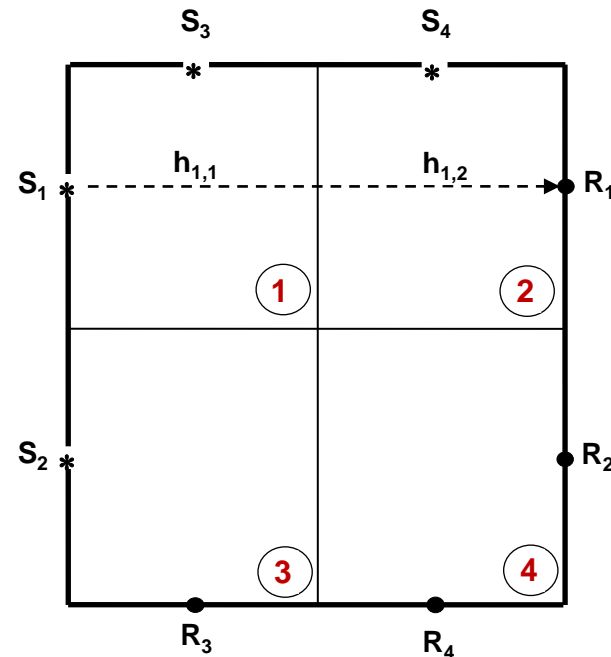
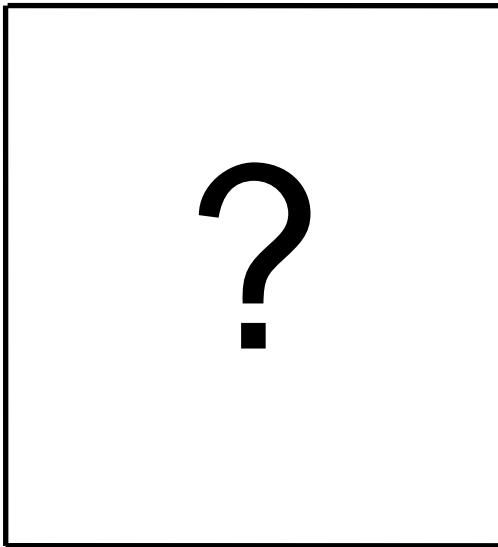

→ design your experiment for "invertibility"

Documentation

*Put it before them briefly so they will read it,
clearly so they will appreciate it,
picturesquely so they will remember it and,
above all, accurately so that they will be guided by its light.*
(Joseph Pulitzer 1847-1911)

*Writing is like putting a puzzle together :
each section is a piece ... when assembled a clear picture emerges!*

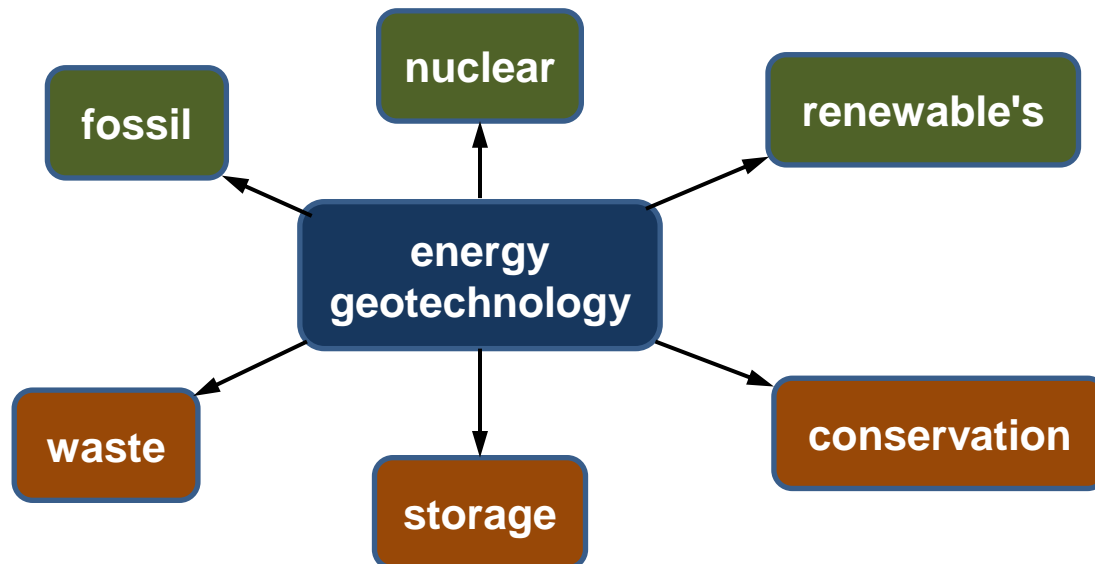

→ complete the energy geotechnology mind-map... do a similar one for your research...

Photographs - Plots

A picture paints a thousand words
(popular saying)

You don't take a photograph, you make it
Ansel Adams (1902-1984)

Bioengineered Aussois

→ analyze plots in presentations/journals: clear? complete?

Pathological Science: Ethics, Plagiarism

The community of scientists is bound by a set of values, traditions, and standards that embody honesty, integrity, objectivity, and collegiality.

(National Academies, 1992)

Examples

1989: Cold Fusion Fiasco (B. Stanley Pons and Martin Fleischmann - University of Utah)

1992: Fracture mechanics (Fabrikant - Concordia U., Canada)

2005: Cloning (Woo Suk Hwang and co-workers, Seoul National University)

2010: Climate Science??

Plagiarism:

The thief. copy without mutation... and do not reference (uncommon)

The pretender. copy, but reword extensively to erase all evidence of source of inspiration

Misleading sub-referencing. Source of inspiration is referenced but in a secondary context

Make them happy. Reference the author for a secondary article ... and hide the key article.

The unifier. Refer the thesis by Smith, and hide the journal article by Smith with famous advisor.

The oblivious co-author. Co-author "A" was inspired by reference by Jones, but does not tell co-author "B" and the reference is not included → both share the responsibility for plagiarism!

Research: Energy Demanding

You have a choice: to make ... or not to make a difference

Why a profession ? Let it be your vocation

Enjoy !!!